

CALE-48 SERIES

Constant Current LED Driver

DANUBE

FEATURES

- EFFICIENCY UP TO 96%
- CONSTANT CURRENT LED DRIVER
- WIDE INPUT AND OUTPUT VOLTAGE RANGE
- INPUT VOLTAGE UP TO 52V
- PWM DIMMING CONTROL
- SHORT CIRCUIT AND OVERTEMPERATURE PROTECTED
- INTERNAL SMD TECHNOLOGY
- FULLY ISOLATED PLAST2C CASE WITH IP67 LEVEL
- UL 94V-0 PACKAGE MATERIAL
- RoHS COMPLIANT
- 3 YEARS WARRANTY

IP67

CE

FC

REACH
COMPLIANT

RoHS
COMPLIANT

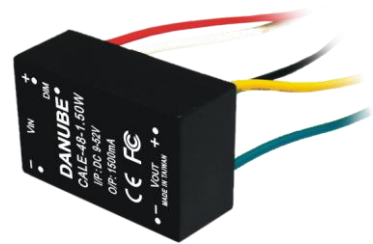
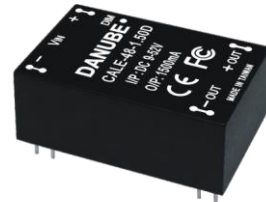

DESCRIPTION

CALE-48 series is a high efficiency, constant current and step-down DC/DC converter. The LED DRIVER operates from an input voltage 9Vdc to 52Vdc and provides an externally adjustable output current of up to 1500mA and output power up to 54 watts. It is able to include the function of Over temperature protection(OTP), Over current protection(OCP), PWM/Digital Dimming and ON/OFF. The device can extensively be used for Landscape illumination, Special illumination, Back light source, Commercial illumination, Street light illumination, Home use illumination and Automobile illumination etc.

SELECTION GUIDE

MODEL NUMBER	INPUT NOMINAL VOLTAGE (VDC)	INPUT VOLTAGE RANGE (VDC)	OUTPUT VOLTAGE RANGE (VDC)	OUTPUT CURRENT RANGE (mA)	DIMMING CONTROL	EFF (% Typ.)
CALE-48-1.00D(W)	48	9-52	2-46	0-1000	PWM	96
CALE-48-1.20D(W)	48	9-52	2-46	0-1200	PWM	96
CALE-48-1.50D(W)	48	9-52	2-46	0-1500	PWM	96

● PARTNUMBES STRUCTURE

Series	Coding Scheme	
CALE-48 Series	CALE-x1-x.x2y1zzz	CALE = Series Name x1 = Input Voltage x.x2 = Output Current y1=Package Style(D=PINS)(W=WIRED) Zzz = 0~9 , A~Z or blank for market purpose.

SPECIFICATIONS

(Typical at 25°C, nominal input voltage, rated output current unless otherwise specified)

Project	Working Condition	Min.	Typ.	Max.	Unit
Input Voltage(absolute maximum)				52	VDC
Recommended Input Voltage		9	48	52	VDC
Input Filter		Capacitor			
Output Voltage range	Vin=52V	2		46	VDC
Output Current Accuracy	Vin=48V,10LEDS		±4	±6	%
Output Current Stability	Vin=48V,1LED to 10LEDS		±4	±6	%
Maximum Capacitive Load				10	uF
Operating Frequency				1000	KHz
Short Circuit Protection		Continuous			
Temperature Coefficient	-40°C~+71°C ambient			±0.03	%°C
Operating Temperature	1000mA/1200mA	-40		71	°C
	1500mA	-40		65	°C
Storage Temperature		-55		125	°C
Humidity(D) (W)				95	%
Over Temperature Shutdown (Auto-restart after cool down)	Internal IC Temperature		155		°C
	Temperature Hysteresis		30		°C
Maximum Case Temperature				105	°C
MTBF (using MIL-HDBK 217F)	Operating Temperature 25°C	2000000			Hours
Case Material		Non Conductive plastic			
Potting Material		Epoxy (UL94V-0)			
Case Size(D)(W)		31.8*20.3*12.2			mm
Weight(D)			15.6		g
Weight(W)			18		g
EMI Radiated Emissions		EN55015			
Dust Test & Waterproof Test (D) (W)		IP67			

● **PWM DIMMING AND ON/OFF CONTROL** (Leave open if not use)

Project	Working Condition	Min.	Typ.	Max.	Unit
ON/OFF Control	ON (DIM ~ -VIN)	2.5	FLOAT	6	VDC
	OFF (DIM ~ -VIN)	0		0.8	VDC
Quiescent Input Current in Shutdown Mode	Vin=24			1	mA
PWM Frequency	For Linear Operation	100		1K	Hz
	(measured 1%~100% Dimming)				

● **PWM DIMMING AND ON/OFF CONTROL** (measured 1%~100% Dimming)

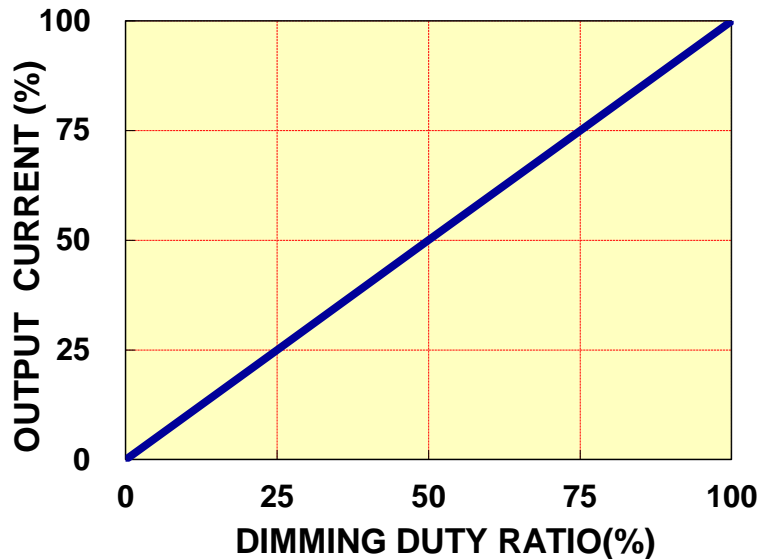
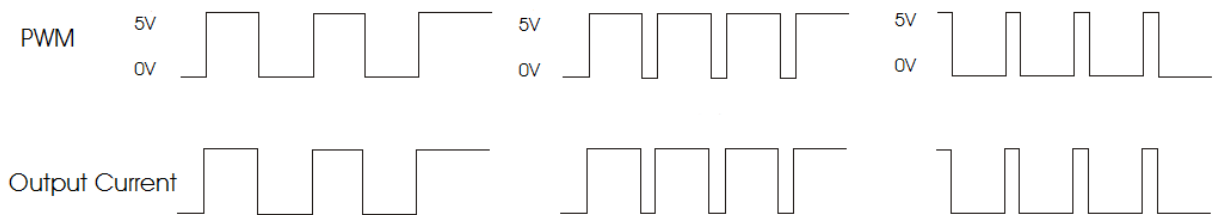

Fig.1 Dimming Duty Cycle:1%-100%

The dimming of LEDs can be performed by applying PWM signals to DIM pin. The following Fig.1 show good linearity in dimming application of **CALE Series**. A logic low (below 0.8V) at DIM PIN will disable the device and shut off the current flow to the LED array.

● **TYPICAL APPLICATIONS**

PWM Dimming control circuit

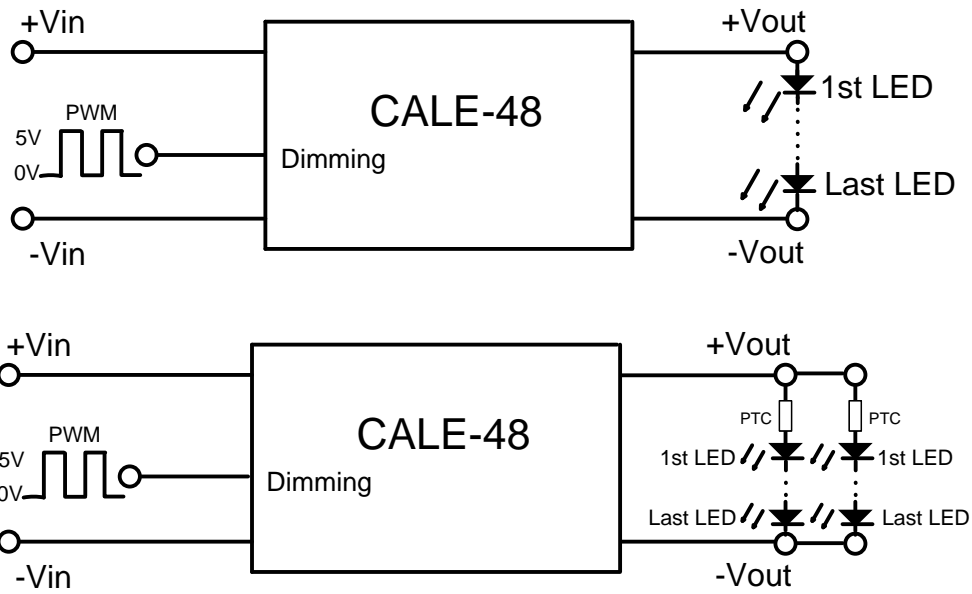
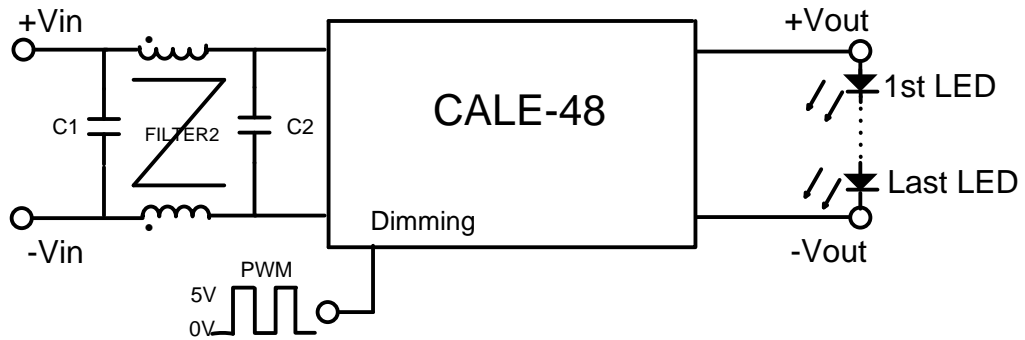

Fig.2

In actual use, if necessary to protect LED, a PTC of positive temperature coefficient may be connect to the input end of every channel or all channels, as shown in Fig.2.

EMI filter circuit



● **EFFICIENCY VS. LOAD LED** $T_A=25^{\circ}\text{C}$

1-LED $V_F=3.6\text{V}$; 2-LED $V_F=7.2\text{V}$; 3-LED $V_F=10.8\text{V}$; 4-LED $V_F=14.4\text{V}$; 5-LED $V_F=18\text{V}$;

OUTPUT CURRENT 1.00A

OUTPUT CURRENT 1.20A

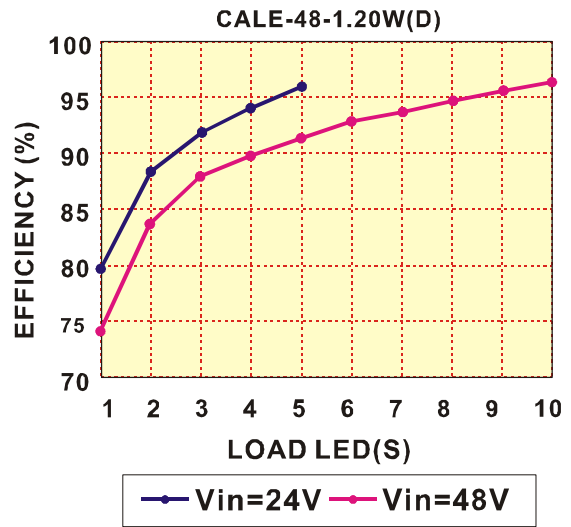
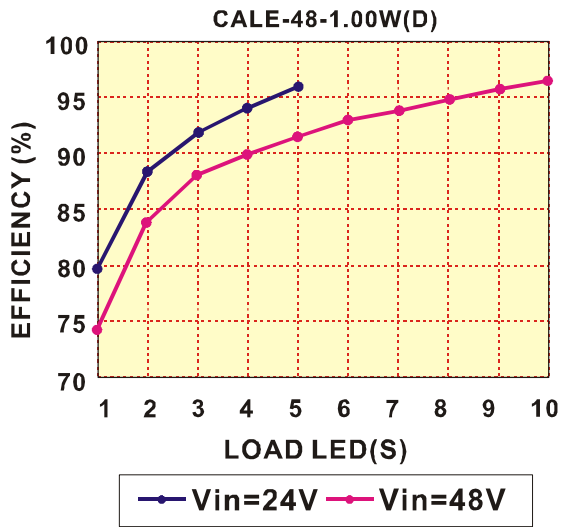

OUTPUT CURRENT 1.50A

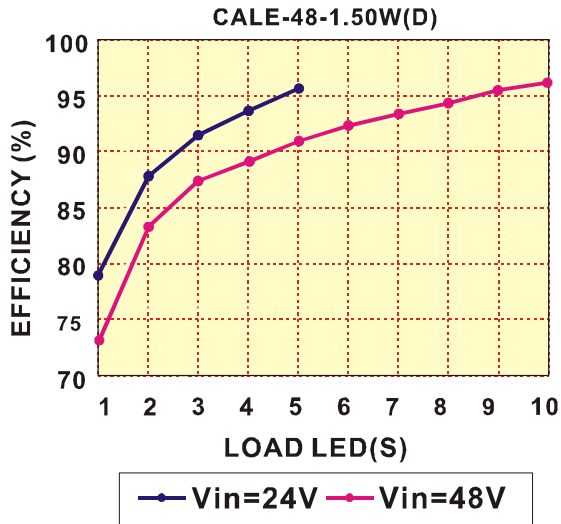

● DERATING CURVE

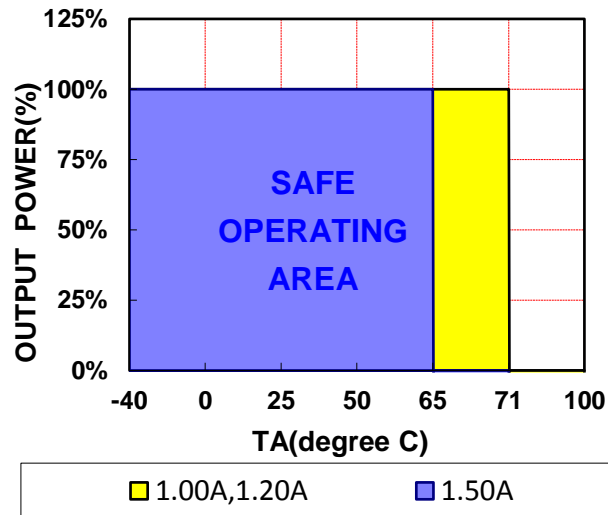

● MECHANICAL DIMENSIONS RECOMMENDED FOOTPRINT DETAILS

PACKAGE "DA"

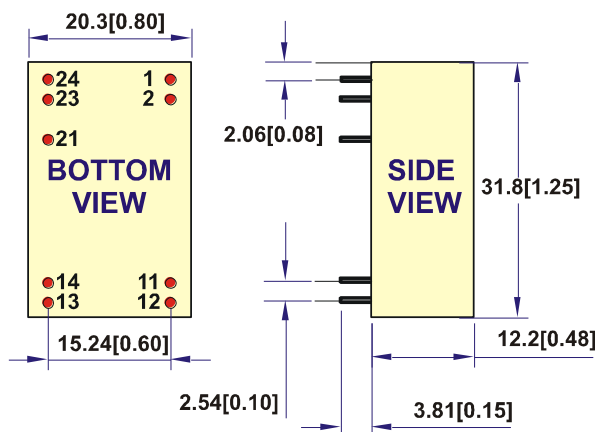

PINOUT		COMMENT
1 & 2	-Vin	Don't connect to -Vout
11 & 12	-Vout	LED - Connection
13 & 14	+Vout	LED + Connection
21	PWM DIM	ON/OFF/PWM Dimming Leave open if not used
23 & 24	+Vin	DC Supply

All dimensions are in mm[inches]

NOTE:

Pin Size is Tolerance 0.60Φ ±0.05mm

All dimensions are in mm(Inches)

Tolerance .X or .XX= ±0.5mm

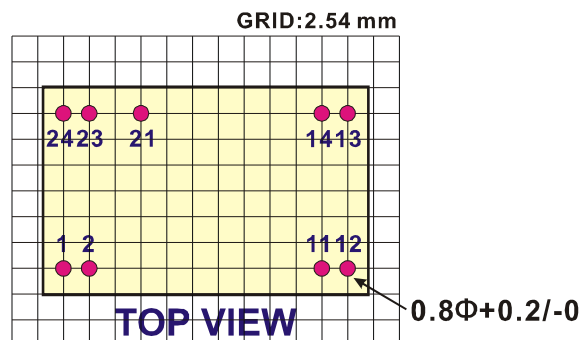

PACKAGE "W"

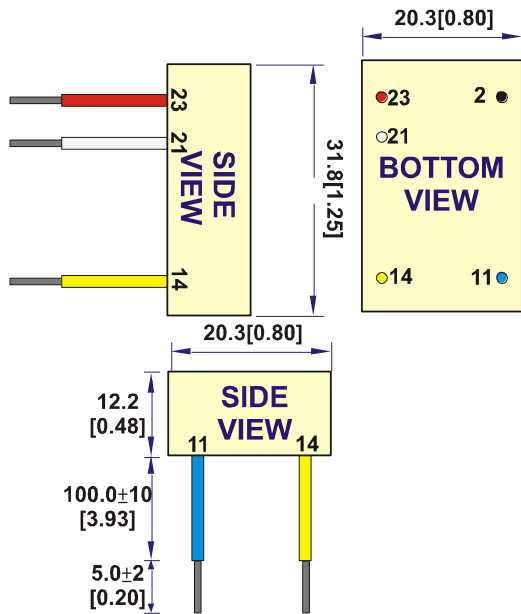

All dimensions are in mm[inches]

PINOUT		COMMENT
2 (Black)	-Vin	Don't connect to -Vout
11 (Blue)	-Vout	LED - Connection
14 (Yellow)	+Vout	LED + Connection
21 (White)	PWM DIM	ON/OFF/PWM Dimming Leave open if not used
23 (Red)	+Vin	DC Supply

NOTE:

All dimensions are in mm(Inches)

1. Case Tolerance .x or .xx ± 0.5 mm

2. Wire outside diameter = 1.6mm ± 0.1

3. Wire core diameter = 0.75mm ± 0.1

4. Wire is UL 3385/CAS TEM listed #22AWG /300V /105°C

Rated

FOR MORE INFORMATION CALL:

Danube Enterprise Co., Ltd.

Tel: 886-7-3755165

Fax: 886-7-3755330

E-mail: danube@ms10.hinet.net

Home Page

<http://www.danube.com.tw>

DANUBE

<http://www.danube.com.tw>

7

2016/09/23